

Brookstone®

Smart Baby Monitor and Camera

USER MANUAL



FCC ID: 2AQ7B-IPC163



RoHS



FCC Statement:

1. This device complies with Part 15 of the FCC Rules. Operation is subject to the following two conditions: (1) this device may not cause harmful interference, and (2) this device must accept any interference received, including interference that may cause undesired operation.

Caution: The user is cautioned that changes or modifications not expressly approved by the party responsible for compliance could void the user's authority to operate the equipment.

Note: This equipment has been tested and found to comply with the limits for a Class B digital device, pursuant to part 15 of the FCC Rules. These limits are designed to provide reasonable protection against harmful interference in a residential installation. This equipment generates uses and can radiate radio frequency energy and, if not installed and used in accordance with the instructions, may cause harmful interference to radio communications. However, there is no guarantee that interference will not occur in a particular installation. If this equipment does cause harmful interference to radio or television reception, which can be determined by turning the equipment off and on, the user is encouraged to try to correct the interference by one or more of the following measures:

- Reorient or relocate the receiving antenna.
- Increase the separation between the equipment and receiver.
- Connect the equipment into an outlet on a circuit different from that to which the receiver is connected.
- Consult the dealer or an experienced radio/TV technician for help.

2. This equipment complies with FCC radiation exposure limits set forth for an uncontrolled environment. This equipment should be installed and operated with a minimum distance of 20cm between the radiator and any part of your body.

For more products please visit www.brookstone.com

WARRANTY INFORMATION

One Year Limited Warranty.

Customer Service: 732-994-2301; email: help@smartpointco.com

The BROOKSTONE trademark, names and logos are owned by

BKST Brand Holdings LLC ©2020. All rights reserved

Manufactured, marketed and distributed by Smartpoint LLC, under license

Google, Android and Google Play are trademarks of Google LLC.

App Store® is a registered trademark of Apple, Inc

All trademarks and Registered trademarks are property of their respective owners

Made in China

©Smartpoint LLC,

250 Liberty Street Metuchen NJ, Suite 1A

SPECIFICATIONS

Model: BkWIFICAMB

Resolution: 1920x1080

Alarm: Motion and sound detection

Night Vision: up to 5m

Frame rate: Up to 15 fps

Sensor: 1/3 CMOS

Viewing Angle: 100°

Audio: Microphone & Speaker built-in

Micro SD Card Storage: Up to 32GB

Compression: H.264

Power: 5V/1A (USB)

Operating System:

Android™ 8.0 or higher, iOS 10.0 or higher

FEATURES

- Wi-Fi remote controlled through App
- Night vision
- Motion detection
- Sound detection
- Dimmable night light
- Two-way audio
- Live video
- Video recording
- Takes still photos
- Detects temperature in room
- Plays 3 different lullabies and white noise

Items included in package:

Camera, Magnetic Stand, Silicone Teddy Bear Stand, Adapter, USB Cable, Mounting Kit and User Manual.

PRODUCT CONFIGURATION

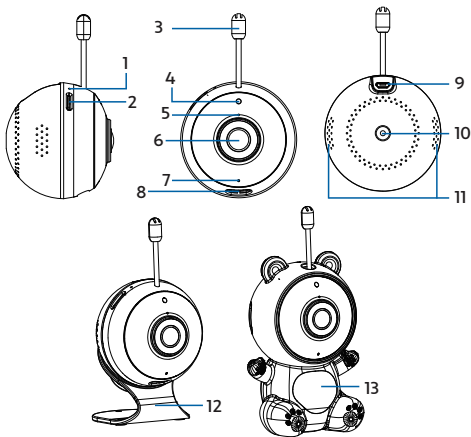

1. Reset Button
2. Micro SD Card Slot
3. Temperature Sensor
4. Light Sensor
5. Built-in MIC
6. Lens
7. Indicator Light

8. Night Lamp
9. Micro USB
10. Tripod
11. Dual Speakers
12. Magnetic Base
13. Teddy Silicone Case

DOWNLOAD APP

1. Android: download “Brookstone Smart” app on Google Play.
2. iPhone: download “Brookstone Smart” app from the App Store.



Brookstone Smart



REGISTRATION AND LOGIN

1. Run the “Brookstone Smart” app from your smart phone.
2. Register and login.

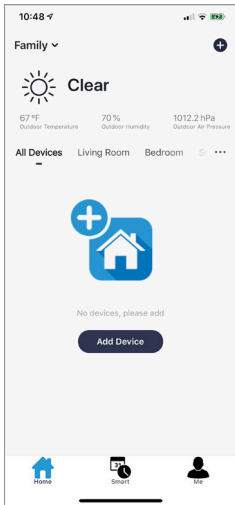
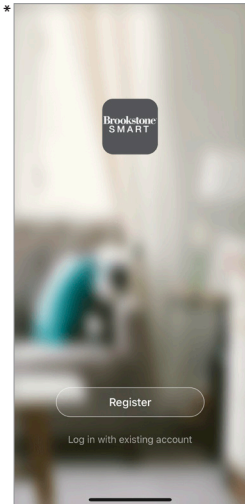

*Screenshots may slightly differ from actual app.

ADD DEVICE

1. Plug in the Camera and wait for red light to blink rapidly and you hear a chime. If it doesn't, press reset button for 3-6 seconds with the included pin, then release and wait for red light to blink rapidly. Light will start blinking and you will then hear a chime sound. Camera is now ready to be set up.
2. Make sure phone is connected to your Wi-Fi network and that it is a 2.4GHz network.
3. Press the (+) symbol in the top right corner of the app and select the Smart Camera from the list of devices to add.



4. Press the “next step” button
5. Make sure phone is connected to the Wi-Fi network that the device will be connected to. Enter your password for the Wi-Fi network.
6. Follow the directions in the app and hold the QR code on the screen in front of the view of the camera.

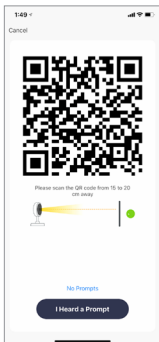
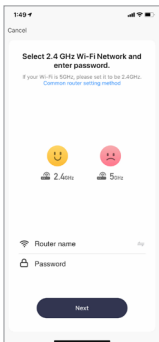
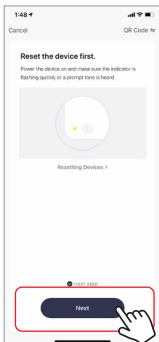

7. Connecting process will begin. Do not turn off Wi-Fi Camera or phone while connecting. Wait for connection process to complete.
8. Once device has been successfully added, name the device what you would like it to be called in the app. The Wi-Fi Camera is ready for use.

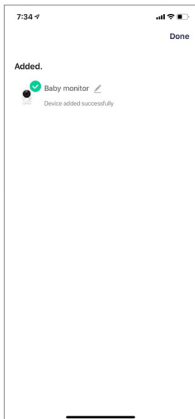
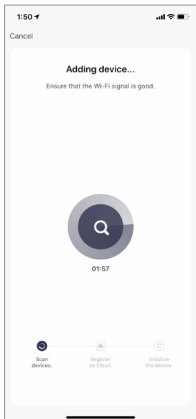

PUSH NOTIFICATIONS

1. You can turn on/off notifications for all devices connected to app by clicking on the “Me” button at the bottom right of the screen.
2. Then click on “Settings” button. From there you can turn on/off all notifications.
3. To view notifications in the app, click on “message center” on the “me” tab on the bottom.

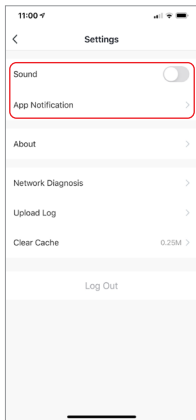
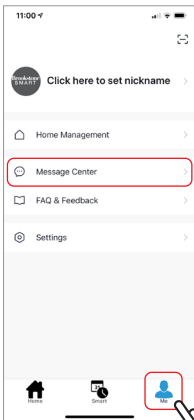

REMOVE A DEVICE

1. From the home screen, click on the device you would like to remove.
2. Then click on the edit symbol on the top right of the screen.
3. From there you would then click the “Remove Device” button at the bottom of the screen.

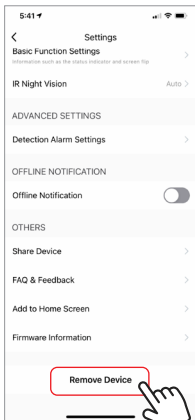
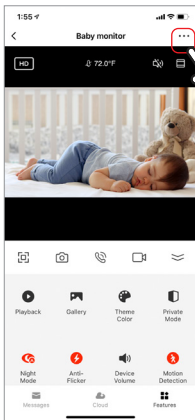

MAGNETIC STAND & SILICONE BEAR COVER

Stand and Mount options

The camera comes with two different stand choices.

1. You can place the camera in the soft silicone bear stand to have it appear as a toy so that your baby or child will enjoy what it looks like.
2. You can also place it in the magnetic base and use it as a normal smart camera. The base allows the camera to be pointed in almost any direction and you can use the holes in the bottom to mount on the wall.



APP FUNCTIONS

Live Video

To view live video simply click on the device under “All devices” and select the camera you just added. Hit the full screen button in the top left corner to see your live footage at full screen on your phone.

To hide the control panel, you can press the top right button. To view the control panel again, press the same button again.

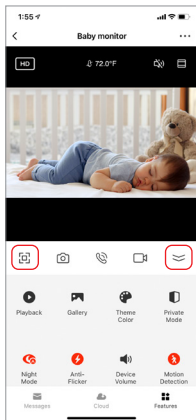
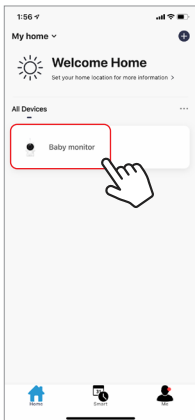

Video Recording

To record video press the “camera” button at the top of the control panel. To end recording, press the “camera” button again. The photo and video will be saved in the APP(iOS) or the photos and video section(Android). To view recordings, press “gallery” button.

Note: If you don't have a Micro SD Card in the camera, Cloud Storage Can be purchased by pressing the “Cloud” button on the bottom of the main screen.

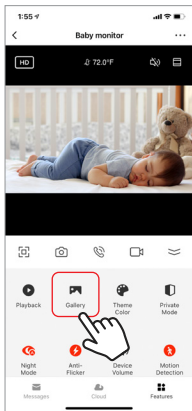
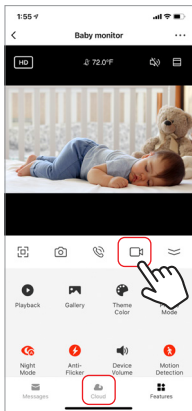

Taking a Photo

To take a photo, press the “camera” button. To view your photos, press the “gallery” button.

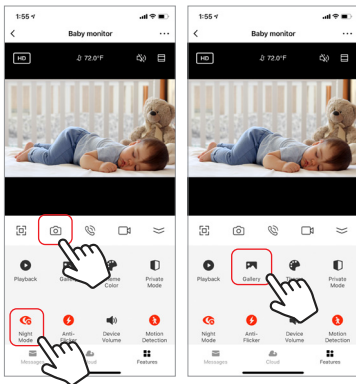

Infrared Night Vision

Night vision mode can be set to Auto/Off/On. To change modes, press the “Night Mode” button. Auto is default, which means the infrared night vision is controlled by the camera automatically. When the area around the camera gets too dark, the infrared night vision activates automatically. When the area around the camera is bright again, the night vision deactivates automatically.

Two Way Audio

To activate two way audio, press the “speak” button. When the button is orange, whatever you say into your phone will come out of the speaker on the camera. You can also hear at the same time any sounds from the live video on the camera.

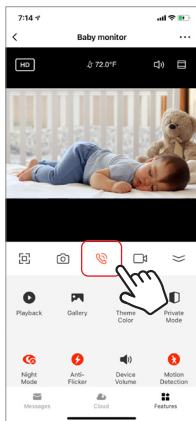
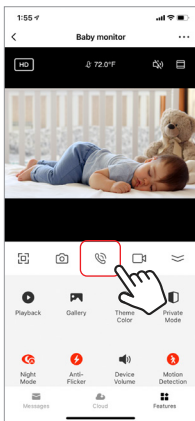

Device Volume

To change the volume on the camera, press the “device button” and then you will be able to change the volume on the camera.

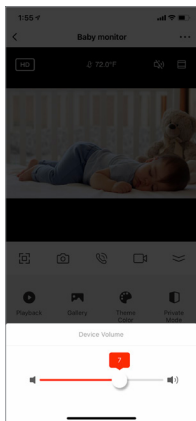
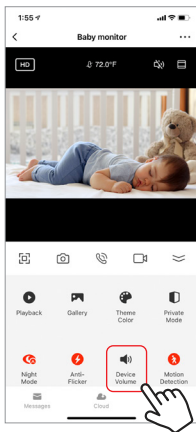

Motion and Sound Detection

The camera uses infrared sensors when someone/something appears within its detection area. It also detects sound so you can hear if your baby is crying. Push notifications will be sent to your phone once motion or sound is detected.

To access controls of the detection alarm settings, press the camera setting button at the top right. You can also get to this from pressing the “Motion Detection” or “Sound Detection” button on the main camera page. You can also set a time window of the day that the alarms will go off by pressing “Schedule” on this page.

To view videos recorded via motion detection press “Playback” on the main screen. You must have a Micro SD Card in the camera or have cloud storage enabled to view these saved videos.

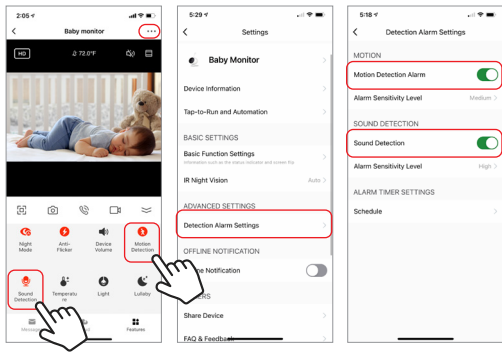

Theme Color

The control panel can be set to “Light Mode” or “Dark Mode”. To change this, press “Theme Color” and a pop up menu will let you select light or dark mode.

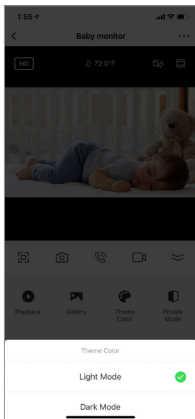
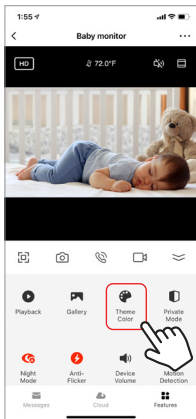

Private Mode

The camera has a private mode. When the private mode is turned on the camera goes to sleep. You can turn this mode on from the main screen by pressing “Private Mode”

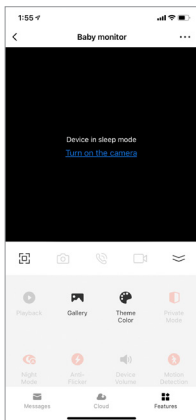
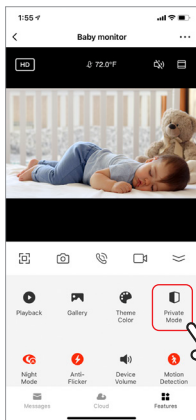

Anti-Flicker

The camera has an “Anti-Flicker” setting if you notice flickering in your footage. Select it from the main screen and choose which frequency works best.

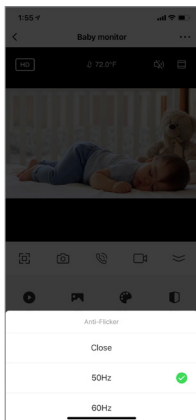
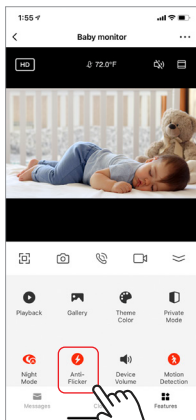

Night Light

The camera has a night light feature that is dimmable. From the main camera screen, press “Light” and the options to control the night light will pop up. You can adjust the dimness from this screen or set a timer for it. When the camera is in the silicone bear cover the light is still visible.

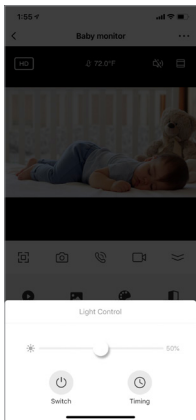
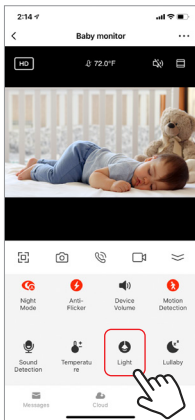

Lullaby's and White Noise

The camera can play 3 different lullaby songs along with the option of just playing white noise. To control this feature, on the main camera screen scroll to the bottom and press "Lullaby". From there, you can control the volume, have the song set on repeat and pick which song you would like the camera to play.

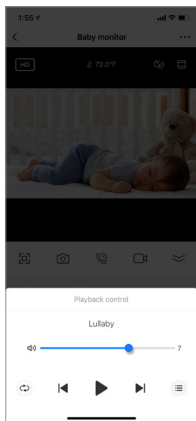
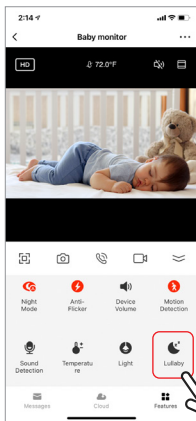

Viewing Temperature in Room

The camera can tell you the temperature of the room it is in. To get to this feature, scroll to the bottom on the main camera screen and press "Temperature". From there you can view the temperature and have the camera send an alert if the temperature gets to an undesired level. You can also change the temperature to Celsius or Fahrenheit.

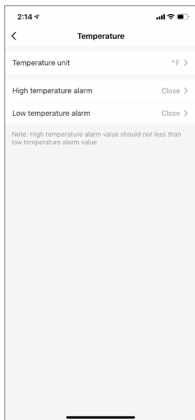
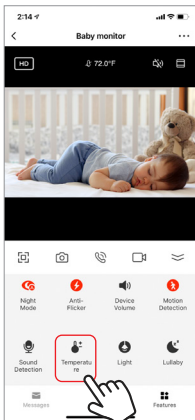

Hub controls (sound, video quality, zoom in/out)

You can control features from the live video feed. There is a volume button that is used to mute and unmute the live feed. There is also a button for the video quality and it can be used to switch between standard and high definition resolution. In the top right there is also a button that can be used for zooming in or out on the footage.

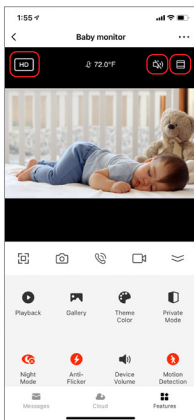

Sharing the Device

To share access to your camera with someone else's Brookstone Smart account, press the camera settings button at the top right of the main camera screen. Then hit "Share Device". On the next page press "Add Sharing" at the bottom. After that, enter the email on the person's Brookstone Smart account that you would like to share the camera with. They will get a notification to accept and after that the other person will have access to view your camera through the Brookstone Smart app on their phone.

